

N 30
D64MAC1X0B
INTEGRATED HOOD
SILVER
60 CM WIDE



B



The Integrated Cooker Hood with a fold out unit is discreetly hidden within the upper cabinets.

- ✓ High extraction rate - for continuously clean air in the kitchen.
- ✓ LED lighting: a clear illumination whilst cooking thanks to the energy-saving LED lights

Features

Technical Data

Typology : Pull-out
 Approval certificates : CE
 Length of electrical supply cord (cm) : 150
 Minimum distance above an electric hob : 500
 Minimum distance above a gas hob : 650
 Net weight (kg) : 10.5
 Type of control : mechanical
 Number of speed settings : 3
 Maximum output air extraction (m³/h) : 620
 Maximum output recirculating air (m³/h) : 410
 Number of lights (Stck) : 2
 Noise level (dB(A) re 1 pW) : 70
 Diameter of air outlet (mm) : 120 / 150
 Grease filter material : Washable aluminium
 EAN code : 4242004223375
 Connection rating (W) : 256
 Current (A) : 10
 Voltage (V) : 220-240
 Frequency (Hz) : 60; 50
 Plug type : GB plug
 Installation type : Wall-mounted



4 242004 223375

N 30
D64MAC1X0B
INTEGRATED HOOD
SILVER
60 CM WIDE

Features

Key performance features:

- Energy Efficiency Class: B (at a range of energy efficiency classes from A++ to E)*
- Extraction rate according to EN 61591 max. 620 m³/h
- Noise max. Normal Level: 70 dB*

Features

- Push button control operation
- 3 power levels
- 2 x 3W LED
- Colour Temperature: 2700 K
- 2 metal grease filter cassettes
- For installation between cupboards

Design

- silver
- Integrated hood
- Hinged door
- Push button control operation
- Mechanical controls

Performance/technical information

- Suitable for ducted extraction and recirculation
- For recirculated extraction charcoal filter (accessory) needed
- Extraction rate according to EN 61591 max. 620 m³/h
- Noise max. Normal Level: 70 dB*
- Noise level according to EN 60704-3 and EN 60704-2-13 at max. normal use exhaust air: 70 dB(A) re 1 pW (56 dB(A) re 20 µPa sound pressure)
- Power rating: 256 W
- Light Intensity: 188 lux
- Colour Temperature: 2700 K
- Electrical cable length 1.5 m
- Diameter pipe Ø 150 mm (Ø 120 mm enclosed)
- Dimensions exhaust air (HxWxD): 402-402 x 599 x 271 mm
- Dimensions recirculating (HxWxD): 402-402 x 599 x 271 mm
- Energy Efficiency Class: B (at a range of energy efficiency classes from A++ to E)*
- Blower Efficiency Class: B*
- Lighting Efficiency Class: A*
- Grease Filtering Efficiency Class: C*
- Average Energy Consumption: 68.4 kWh/year*

Optional accessories

- Recirculating kit

* In accordance with the EU-Regulation No 65/2014

N 30
D64MAC1X0B
INTEGRATED HOOD
SILVER
60 CM WIDE

Dimensioned drawings

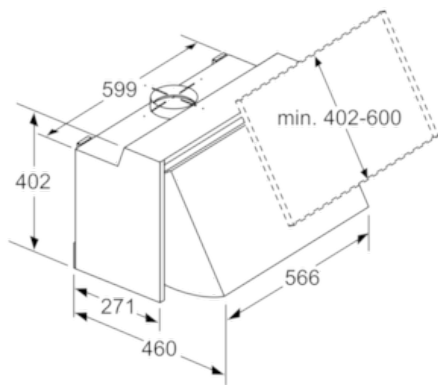

measurements in mm

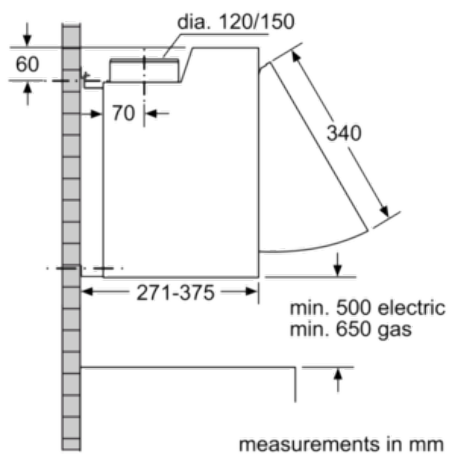

measurements in mm